

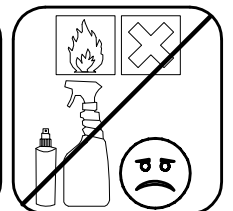

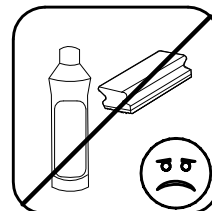

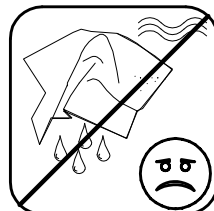

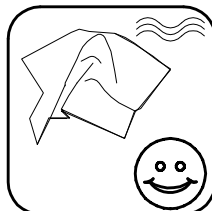

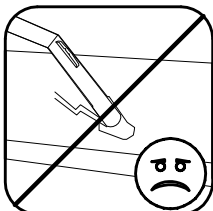
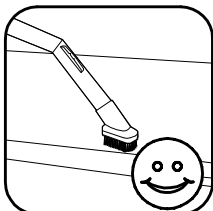
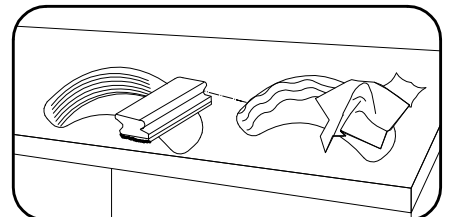
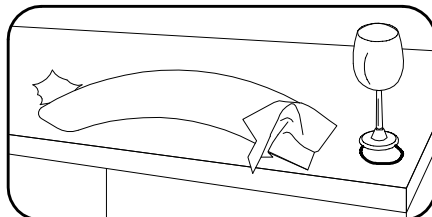
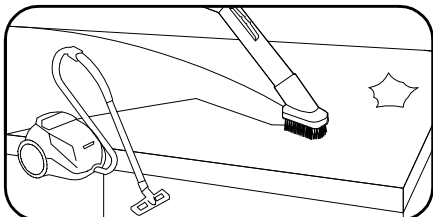
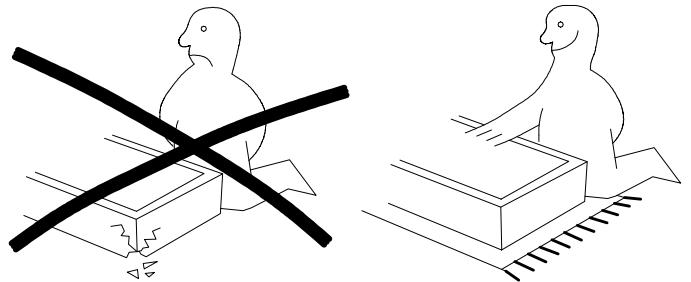
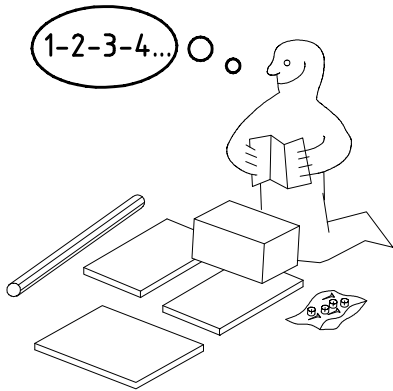
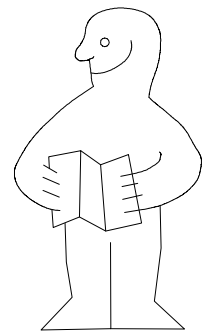
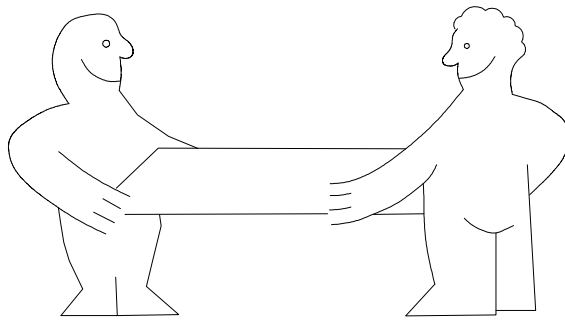
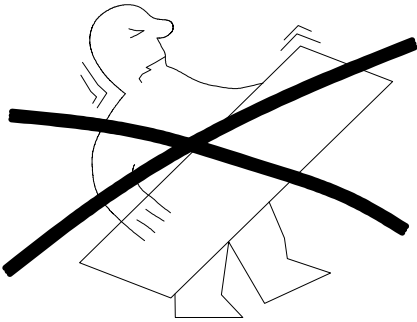
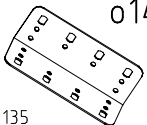
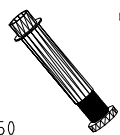
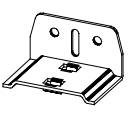
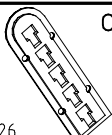

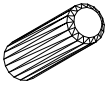

BS 260 uni

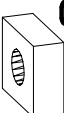
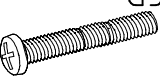

 111 135	o14 4x
 111650	o9 1x
 111 627	o7 6x
 111 626	o6 6x

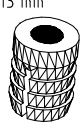
 121 130	4 X 20 mm G22 16x
 121 110	4,0 x 15 mm G23 16x
 121 121	4 X 20mm SP20 16x
 353 018	D ø8 x 30 2x

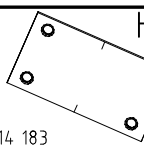
 129 407	US ø12 4x
 121 150	G6 4x
 121 149	5,0 x 35 mm G51 4x
 121 148	6,0 x 12 mm G4 6x

 111 112	ø 10 x 13 mm H 6x
 121128	SP30 4 X 30mm 6x
 114 183	H5 3x
 121 122	SP13 4 X 13mm 12x

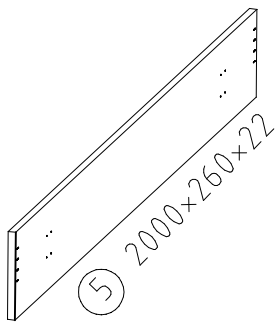
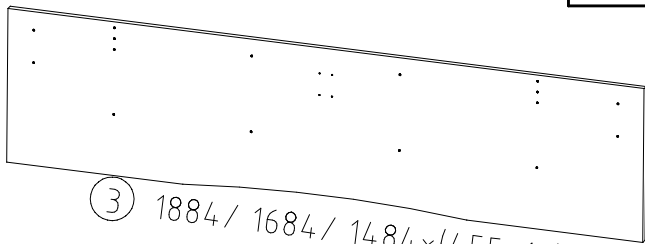
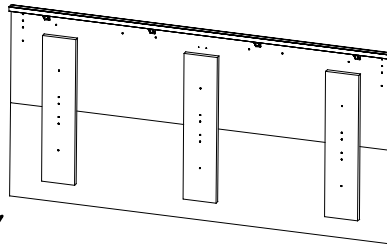
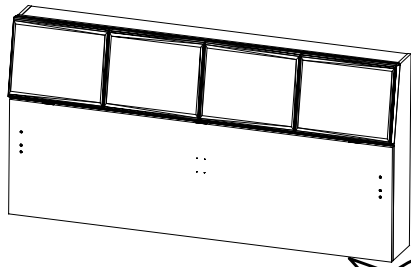
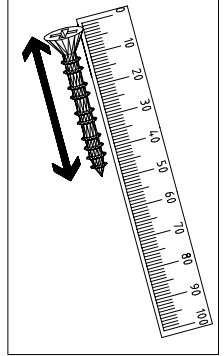
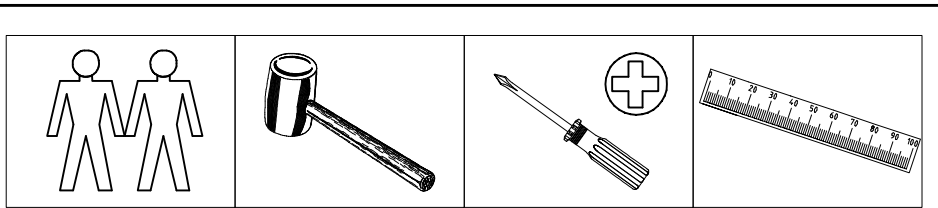
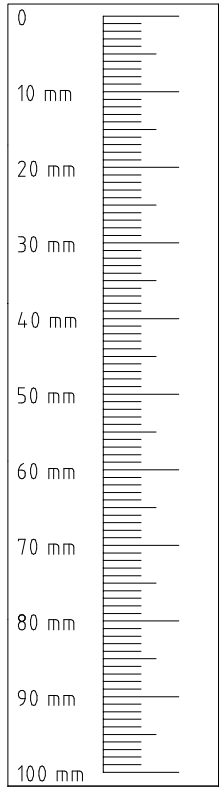

⑤ 2000x260x22

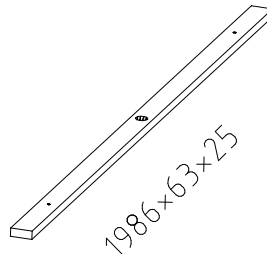

⑥ 1986x63x25

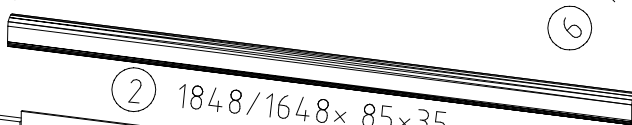

② 1848/1648x 85x35

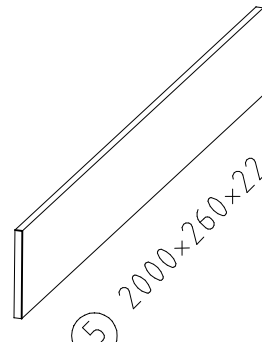

⑤ 2000x260x22

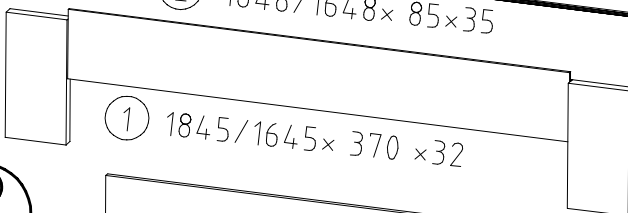

① 1845/1645x 370 x32



④ 1483/1283x 189x15

1

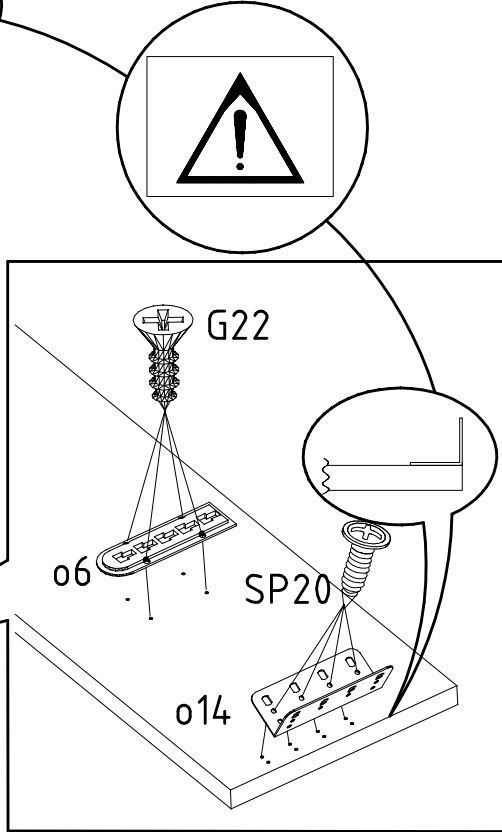
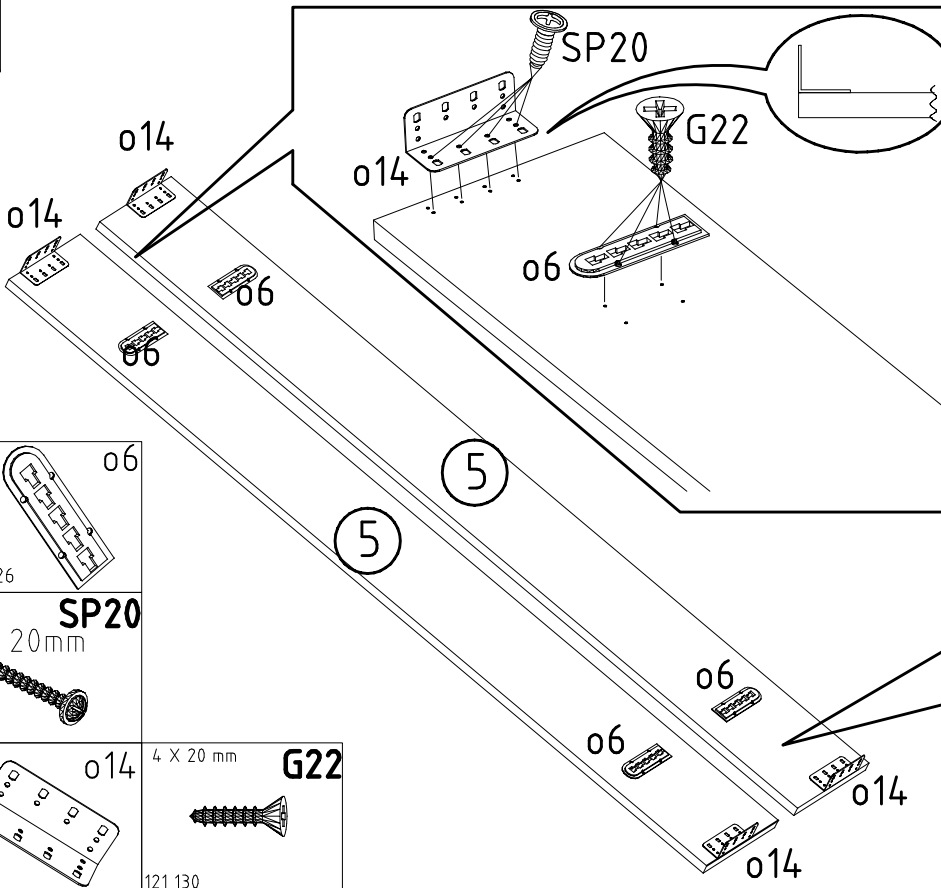

- 06  
111 626
- SP20  
4 X 20mm  
121 121
- 014  
4 X 20 mm  
111 135
- G22  
4 X 20 mm  
121 130

2

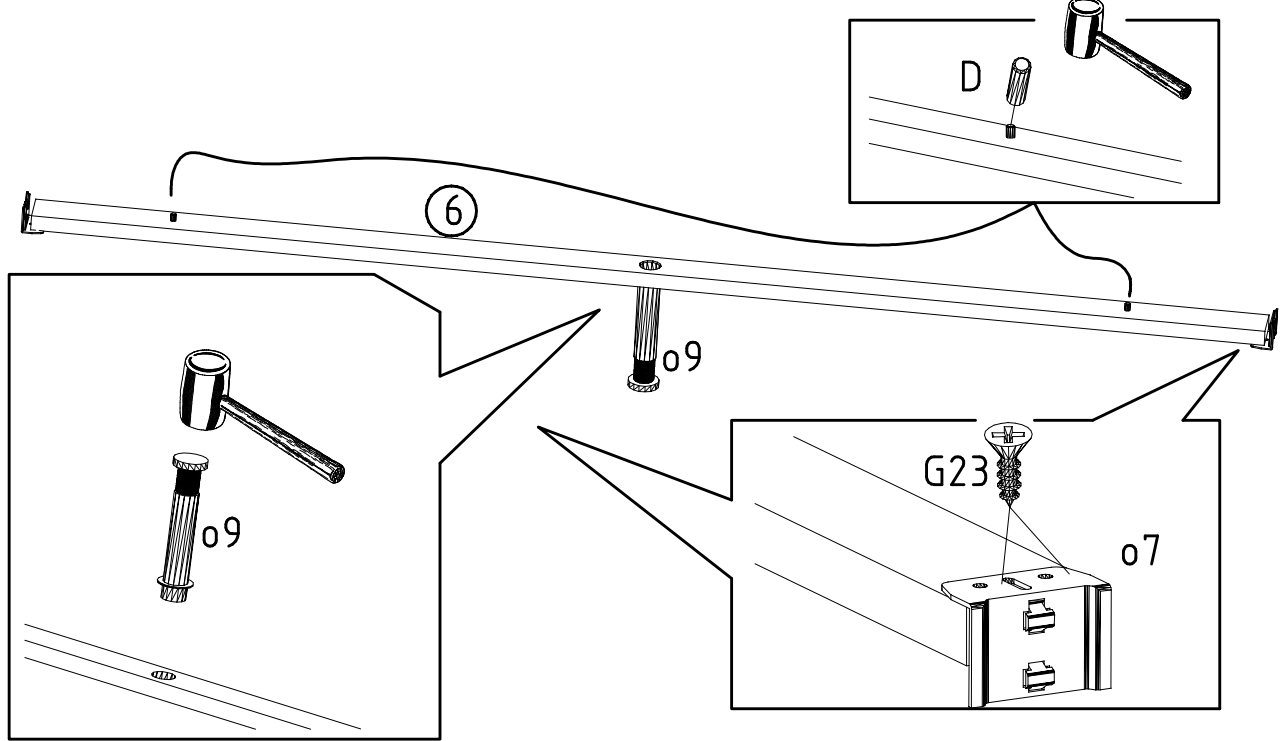

- 4,0 x 15 mm  
G23  
121 110
- 07  
111 627
- 09  
111 650
- D  
353 018  $\phi 8 \times 30$

3

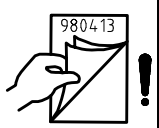
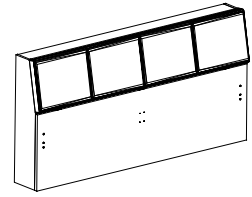
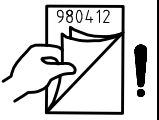
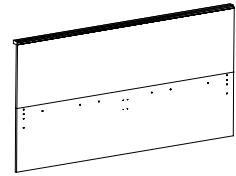
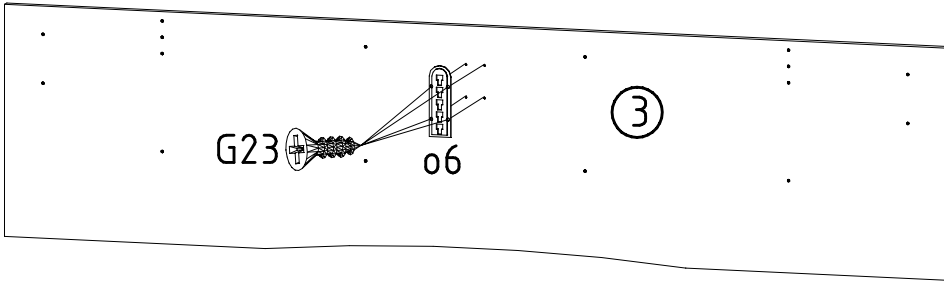
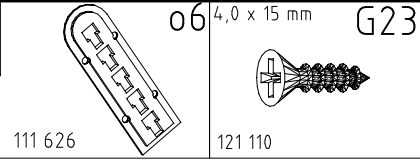

4

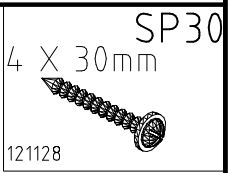
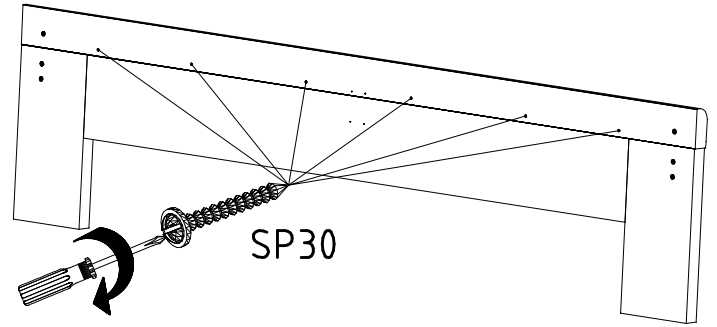
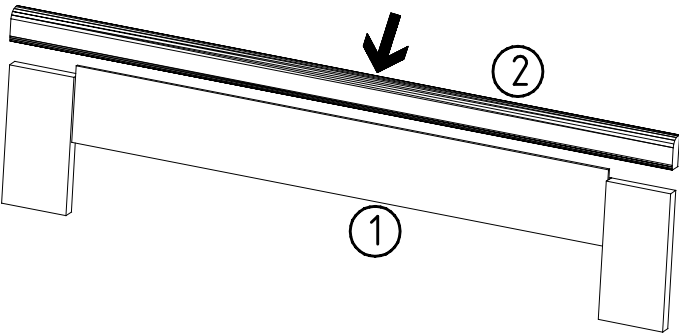

5

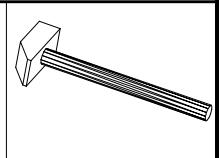
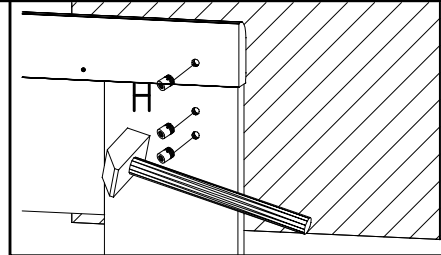
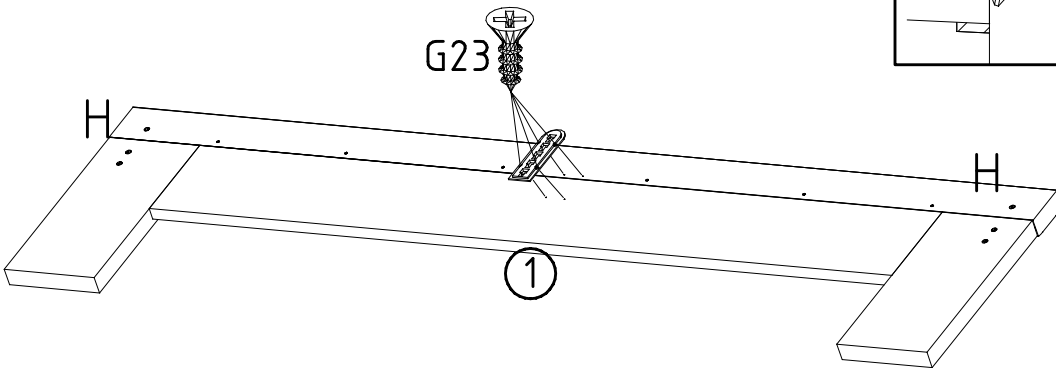
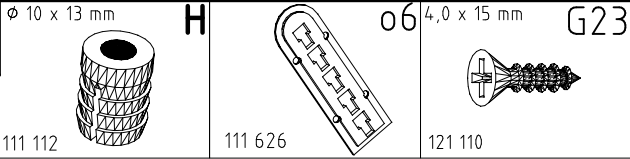

6

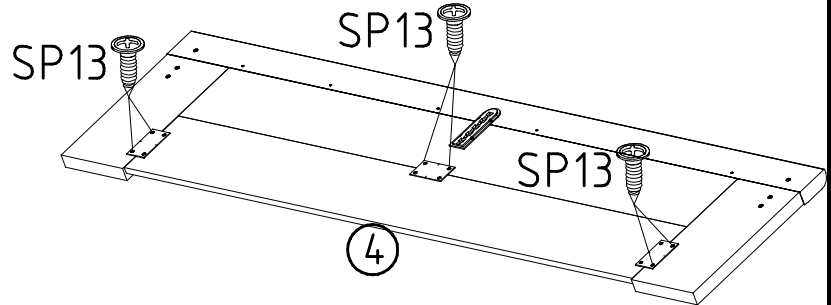
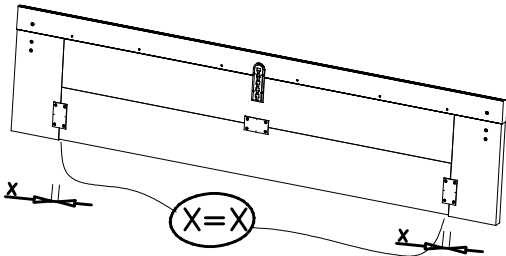
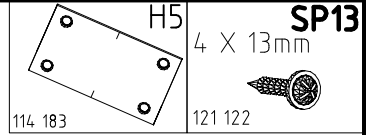
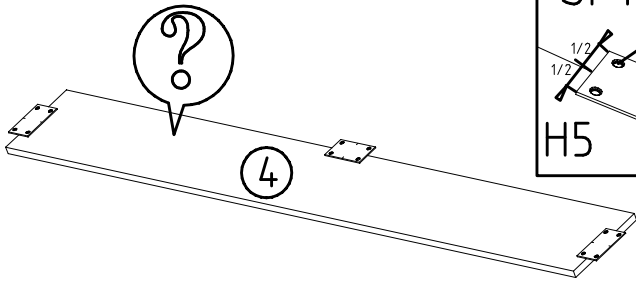

7

